

Riding the wind of innovation

PRICE LIST 2022

Made in Italy

Follow us on



Technological innovation

CMP is always at customer's side and oriented towards a single target: the animal welfare.

Over the years, CMP Impianti has developed the necessary experience and know-how to create excellent products in ventilation industry, improving its systems with constant innovation.

With more than 100.000 fans sold around the world, we represent the benchmark in the ventilation category.

CMP is a market leader in the world, with more than 50 distributors currently dislocated in: Albania, Austria, Belarus, Bulgaria, Croatia, Denmark, France, Germany, Greece, Italy, Lithuania, Malta, Moldova, Netherlands, Poland, Portugal, United Kingdom, Czech Republic, Romania, Slovakia, Slovenia, Spain, Switzerland, Ukraine, Hungary, Cambodia, China, Cyprus, Northern Cyprus, South Korea, Indonesia, Iran, Israel, Laos, Russia, Taiwan, Thailand, Turkey, Vietnam, Algeria, Chad, Egypt, Mali, Morocco, Rwanda, Papua New Guinea, Argentina, Brazil, Canada, Colombia, Ecuador, Panama.

Animals need the best ventilation and CMP systems represent the best solutions to cope with heat stress.

A proper ventilation, ensured by a professional design of the system based on the building's structure and climate condition, is the key to remove harmful gases, to dry the environment and to reduce the negative effects that stem from heat stress.

The wide range of fans, control units and accessories provided by CMP, contributes to develop a perfect ventilation system.

Check our price list to discover several adoptable solutions able to meet anykind of need.



Via A. Vespucci, 22
25012 Calvisano (BS)
+39 030 968 6428
info@cmp-impianti.com

01. Fans

Fans Ø 0,8m

Fans Ø 1m

Fans Ø 1,3m

Fans Ø 1,6m

Fans Ø 2,5m

Fans Ø 3m

Fans Ø 4m

Fans Ø 5m

Fans Ø 6m

Fans Ø 7m

Attention

Remember to specify the type of power supply

■ 230 V ■ 400 V ■ 1 PH ■ 3 PH

02. Control units

Potentiometer _____

MCU _____

THI system _____

Smart controller for cooling area _____

Touch screen _____

Inverter _____

03. ■

Bracket kits

Wall bracket _____

Tubular bracket _____

Metal strip _____

Big bracket _____

04. ■

Lighting

Photoperiod _____

Sensors and controllers _____

Design _____

Contacts _____

Fans

Diameter 0,8m

01.

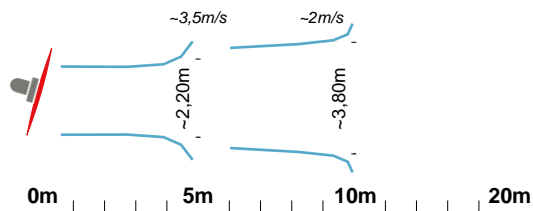

Vertigo

Fiberglass propylene blades



	rpm	kW	Price	Code
--	-----	----	-------	------

Brushless	900	0,72	1588 €	DEZVST0008D7W
-----------	-----	------	--------	---------------

Asynchronous	900	0,85	732 €	DEVEST0008D7W
--------------	-----	------	-------	---------------

Protective net
available: +260€

Fans

Diameter 0,8m

01.

Vertigo

Fiberglass propylene blades

	rpm	kW	Price	Code
Brushless	900	0,72	1712 €	DEZVST0R08D7W
Asynchronous	900	0,85	857 €	DEVEST0R08D7W

Protective net's price included

Three chains not included

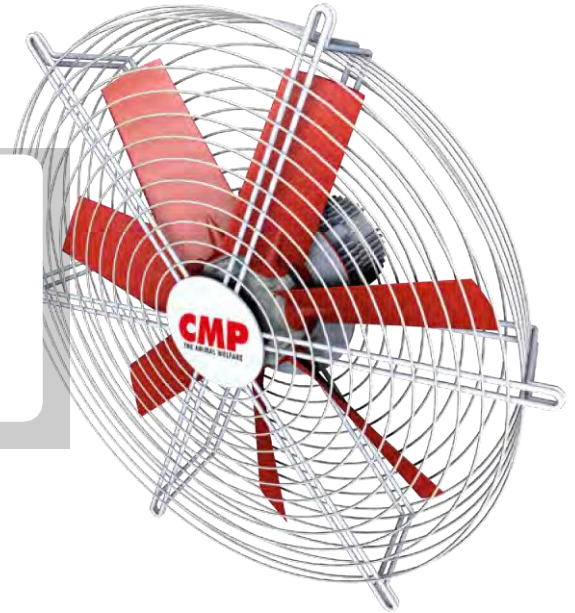

Vertigo

Fiberglass propylene blades

	rpm	kW	Price	Code
Asynchronous	900	0,85	928 €	DEVEST0C08D7W

Protective frontal net: +67€

Three chains not included

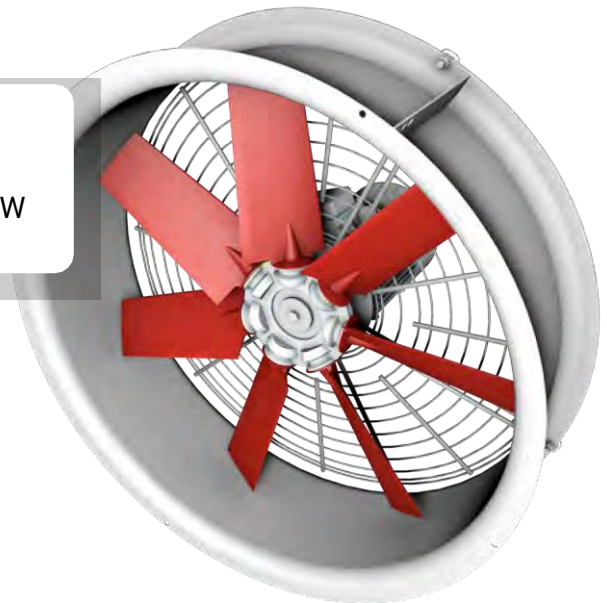

Fans

Diameter 1m

01.

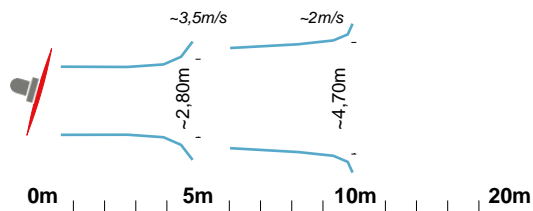

Vertigo

Fiberglass propylene blades

	rpm	kW	Price	Code
Brushless	700	0,65	1547 €	DEZVST0010D5W
Asynchronous	700	1	878 €	DEVEST0010D5W

Protective net available: +330€



Vertigo

Fiberglass propylene blades

	rpm	kW	Price	Code
Brushless	700	0,65	1741 €	DEZVST0R10D5W
Asynchronous	700	1	1082 €	DEVEST0R10D5W

Protective net's price included

Three chains not included

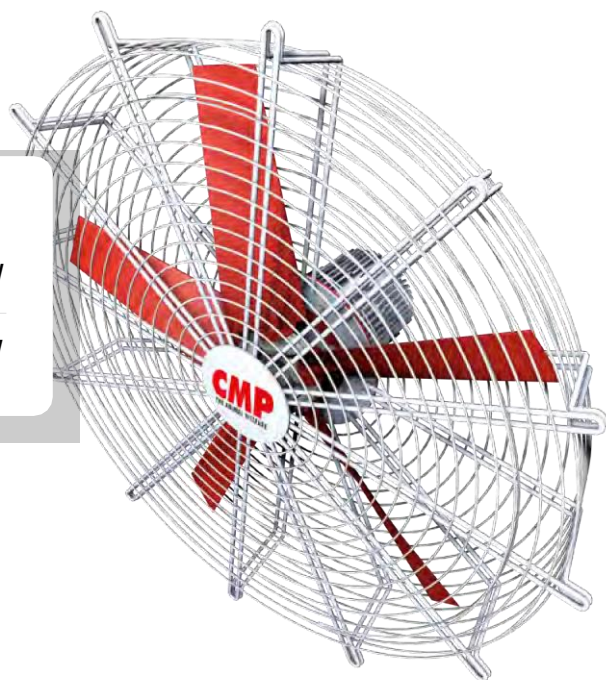

Fans

Diameter 1m

01.

Vertigo

Fiberglass propylene blades

	rpm	kW	Price	Code
Brushless	700	0,65	1547 €	DEZVST0B10D5W
Asynchronous	700	1	878 €	DEVEST0B10D5W

Three chains
not included

Protective net
unavailable

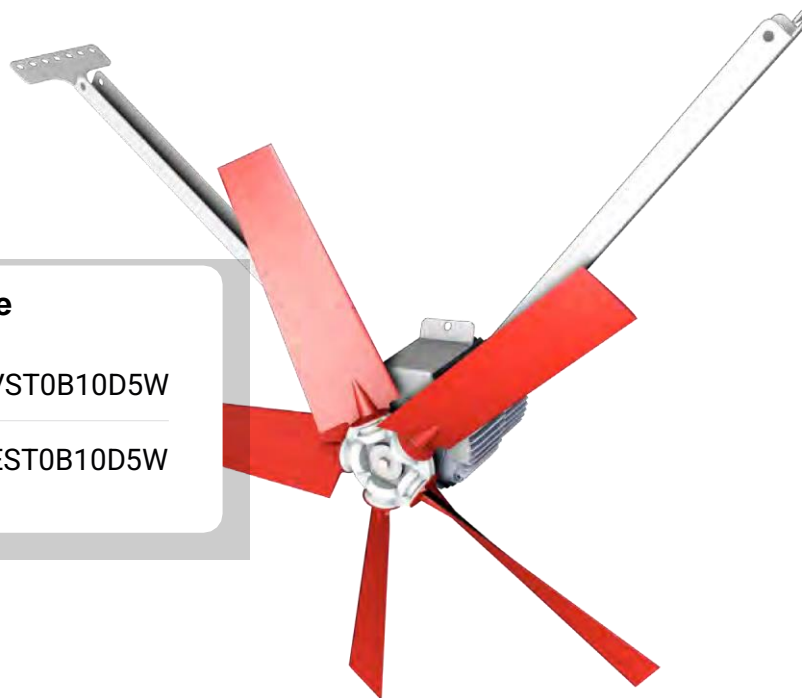

Vertigo

Fiberglass propylene blades

	rpm	kW	Price	Code
Asynchronous	700	1	1117 €	DEVEST0C10D5W

Protective
frontal net: +91€

Protective
posterior net: +87€

Three chains
not included



Fans

Diameter 1,3m

01.

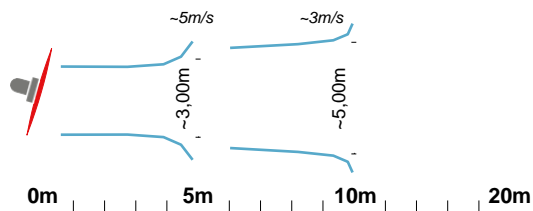

Vertigo

Fiberglass propylene blades

	rpm	kW	Price	Code
Brushless	700	0,65	1691 €	DEZVST0013D3W
Asynchronous	700	0,75	992 €	DEVEST0013D3W

Protective net
available: +465€



Vertigo

Fiberglass propylene blades

	rpm	kW	Price	Code
Brushless	700	0,65	1967 €	DEZVST0R13D3W
Asynchronous	700	0,75	1320 €	DEVEST0R13D3W

Protective net's
price included

Three chains
not included

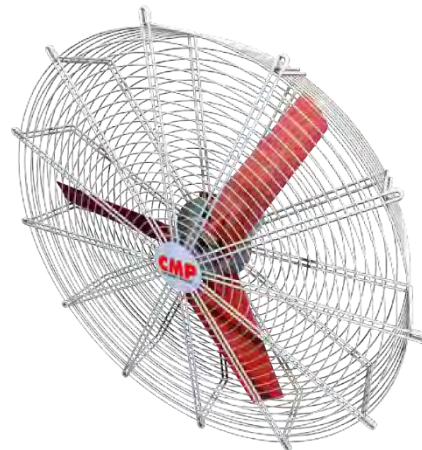

Fans

Diameter 1,6m

01.

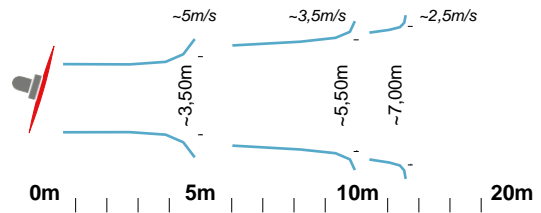

Vertigo

6060 aluminium alloy blades

Brushless motor

	rpm	kW	Price	Code
Normal	500	1	2665 €	DEZVST0016

Protective net
360°: +898€

Protective net
180°: +449€



VSL Vertigo

6060 aluminium alloy blades

	rpm	kW	Price	Code
Normal	500	1,2	1677 €	DEVVST0016

Protective net
360°: +898€

Protective net
180°: +449€



Fans

Diameter 2,5m

01.

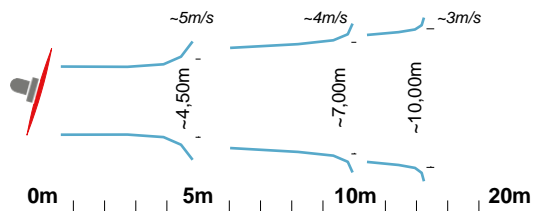

Vertigo

6060 aluminium alloy blades



Brushless motor

	rpm	kW	Price	Code
Normal	230	1,1	2980 €	DEZVST0025
Power	250	1,7	3657 €	DEZVPO0025

Protective net
360°: +1248€

Reverso
version: +90€



VSL Vertigo

6060 aluminium alloy blades

	rpm	kW	Price	Code
Normal	240	1,35	1669 €	DEVVST0025

Reverso
version: +90€

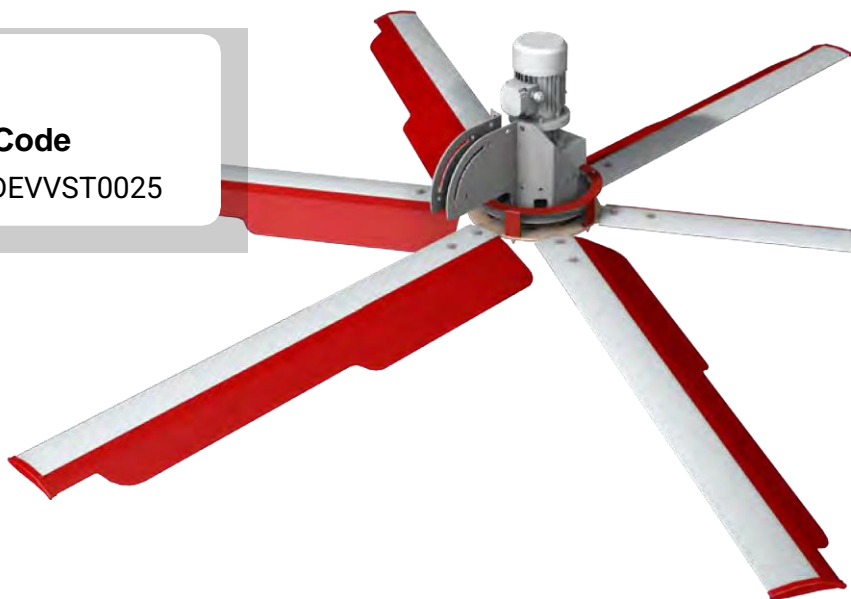

Fans

Diameter 3m

01.

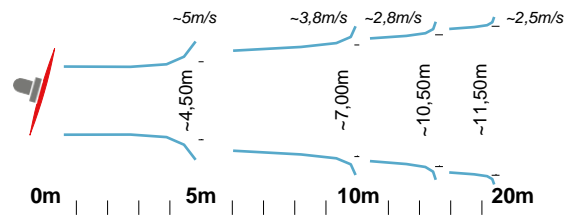

Vertigo

6060 aluminium alloy blades



Brushless motor

	rpm	kW	Price	Code
Normal	165	0,9	3045 €	DEZVST0030
Power	190	1,3	3685 €	DEZVPO0030

Tiltable version: +15€

Reverso version: +100€



VSL

6060 aluminium alloy blades

	rpm	kW	Price	Code
Normal	130	1,4	1735 €	DEVVST0030

Tiltable version: +15€

Reverso version: +100€

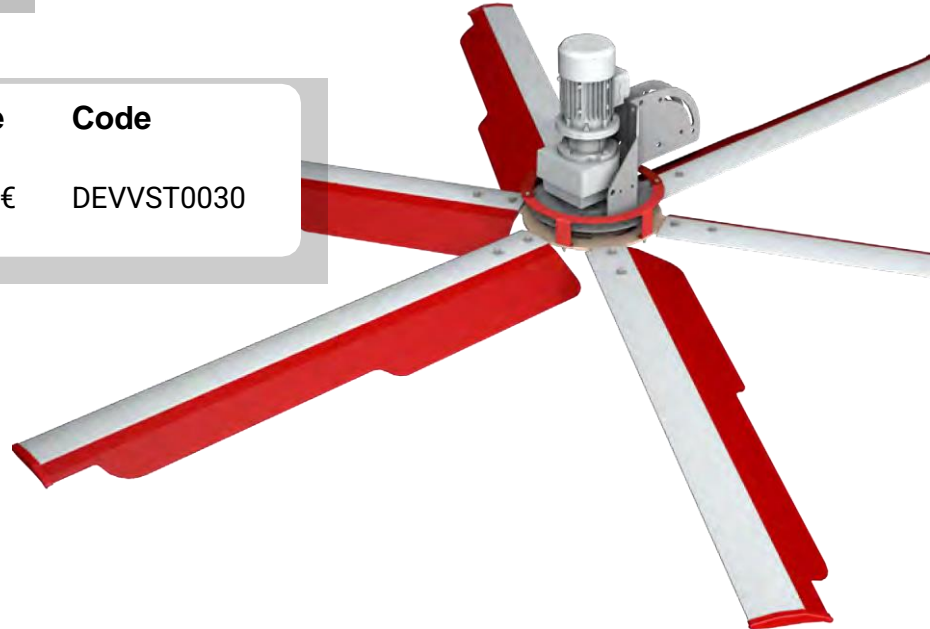

Fans

Diameter 4m

01.

Zefiro

6060 aluminium alloy blades



Brushless motor

	rpm	kW	Price	Code
Normal	110	0,5	2973 €	DEZEST0040
Power	140	1,1	3595 €	DEZEPO0040

Tiltable
version: +15€

Reverso
version: +130€

6 blades
version: +107€



VSL

6060 aluminium alloy blades

	rpm	kW	Price	Code
Normal	110	0,6	1652	DEVLST0040
Power	140	1,35	2134	

Tiltable
version: +15€

Reverso
version: +130€

6 blades
version: +107€



Fans

Diameter 4m

01.

VS

6060 aluminium alloy blades



Axial unloader

	rpm	kW	Price	Code
Normal	110	0,6	2079 €	DEVSST0040

Tiltable
version: +15€

Reverso
version: +130€

6 blades
version: +107€

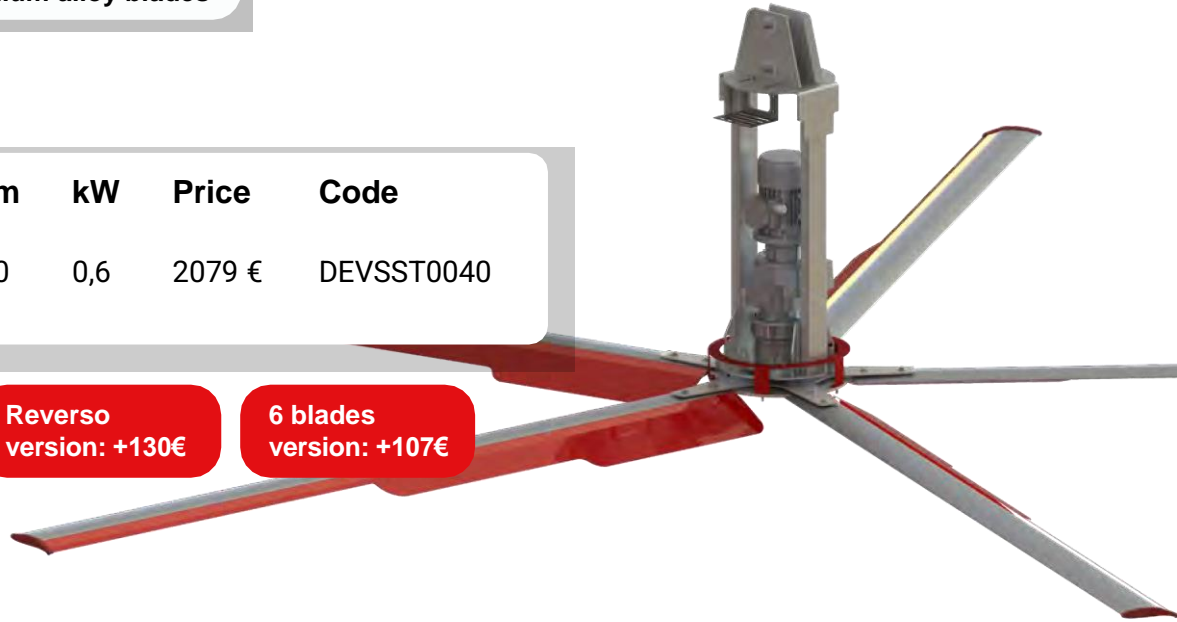

Fans

Diameter 5m

01.

Zefiro

6060 aluminium alloy blades



Brushless motor

	rpm	kW	Price	Code
Light	85	0,6	3110 €	DEZELI0050
Normal	105	0,8	3749 €	DEZEST0050
Power	120	1,7	4294 €	DEZEPO0050

Tiltable
version: +15€

Reverso
version: +130€

6 blades
version: +107€

Ø 4,7m
version: free

VSL

6060 aluminium alloy blades

	rpm	kW	Price	Code
Normal	98	1	2119 €	DEVNST0050

Tiltable
version: +15€

Reverso
version: +130€

6 blades
version: +107€

Ø 4,7m
version: free

Fans

Diameter 5m

01.

VS

6060 aluminium alloy blades



Axial unloader

	rpm	kW	Price	Code
Normal	98	1	2271 €	DEVSST0050

Tiltable
version: +15€

Reverso
version: +130€

6 blades
version: +107€

Ø 4,7m
version: free

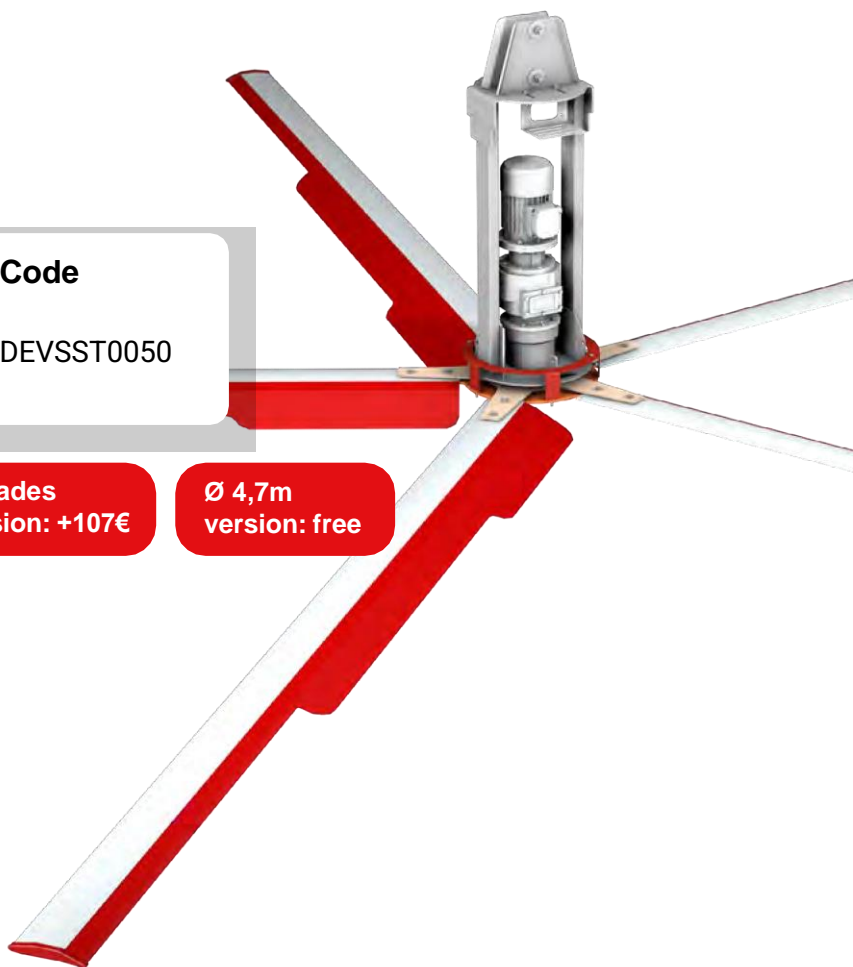

Fans

Diameter 6m

01.

Zefiro

6060 aluminium alloy blades



Brushless motor

	rpm	kW	Price	Code
Light	70	0,7	3841 €	DEZELI0060
Normal	85	1	4387 €	DEZEST0060

Tiltable
version: +15€

Reverso
version: +130€

6 blades
version: +107€

VS

6060 aluminium alloy blades



Axial unloader

	rpm	kW	Price	Code
Normal	86	1,5	2638 €	DEVSST0060

6 blades versi

Reverso
version: +130€

Ø 5,7m
version: free

Fans

Diameter 7m

01.

Zefiro

6060 aluminium alloy blades



Brushless motor

	rpm	kW	Price	Code
Light	60	0,8	3936 €	DEZELI0070
Normal	75	1,2	4480 €	DEZEST0070

6 blades
version: +115€

Reverso
version: +190€

VS

6060 aluminium alloy blades



Axial unloader

	rpm	kW	Price	Code
Normal	73	1,8	2730 €	DEVSST0070

6 blades
version: +115€

Reverso
version: +190€

Control Units 02.

Potentiometer

Max. 5 inverters

	Price	Code
Potentiometer	181 €	CEPOTEPAN000



MCU

Max. 1 zone

	Price	Code
MCU	552 €	CEMCU01Z1T0ZS1
Anemometer	280 €	RRCE0000000015



Temperature probe included

Double

Max. 2 zones

	Price	Code
Double	1581	CECLIM2Z2TOZ
Anemometer	280 €	RRCE0000000015



Temperature probe included

Control Units 02.

THI System

Max. 2 zones

	Price	Code
Small	1744 €	CETHI02Z1U0Z
Anemometer	280 €	RRCE0000000015

Max. 5 zones

	Price	Code
Big	2183 €	CETHI05Z1U0Z
Anemometer	280 €	RRCE0000000015

Temperature/humidity
probe included



Smart controller for cooling area

	Price	Code
Sm. controller cooling area	1691 €	CEDOCA00000001

This control unit allows the farmer to manage the time to wet and dry the cows alternating ventilation and cooling. This system does not work with THI parameters.



CMP
ANIMAL WELFARE

Control Units

Touch Screen

02.

Smart Control Pro 7"



Remote fan control

	Price	Code
Display touch 7"	1180 €	CEBTOU07000ZS1
Slave board	1368 €	CEBTOUSL000ZS1
THI probe	499 €	RRCE0000000016
Anemometer probe	280 €	RRCE0000000015
Solenoid valve	258 €	RAELVA00011400
Modbus redirector	552 €	ACCECASVENT001



Note

Display Touch 7": max 8 zones

Slave board: max 32 inverters modbus and 2 analogic; max 4 for each installation;

THI probe: max 2 for each slave

Anemometer probe: max 1 for installation

Solenoid valve: max 4 for each slave; max 8 for each installation

Modbus redirector 4 lines: max 28 lines for each installation

Control Units

Touch Screen

02.

Smart Total Control 10"



Remote fan control

Included



Remote light control

Included



Cloud-based control

Included

	Price	Code
Display touch 10"	3139 €	CETOUUC10000ZS2
PLC panel	3348 €	CETOU CPA000ZS2
THI probe	499 €	RRCE0000000016
Anemometer probe	280 €	RRCE0000000015
Solenoid valve	258 €	RAELVA00011400
Modbus redirector	552 €	ACCECASVENT001

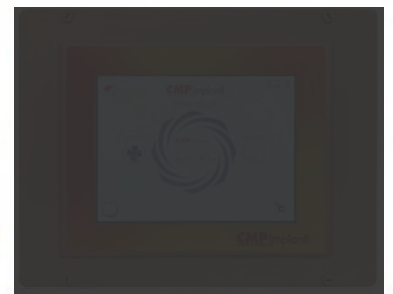

Note

Display Touch 10": max 16 zones

PLC panel: max 32 inverters modbus and 2 analogic; max 5 PLC for each installation;

THI probe: max 2 for each plc

Anemometer probe: max 1 for each installation

Solenoid valve: max 5 for each plc; max 25 for each installation

Modbus redirector 4 lines: max 16 lines for each installation

Control Units

Inverters for Asynchronous motors fans / VS

02.

Wall inverter

400V / Three-phase

Power (kW)	Price	Code
0,8	1260 €	REINVLS0075001
1,5	1372 €	REINVLS0015001
2,2	1415 €	REINVLS0022001
4,0	1532 €	REINVLS0040001
5,5	1575 €	REINVLS0055001
7,5	1705 €	REINVLS0750001
11,0	2362 €	REINVLS0110001
15,0	2630 €	REINVLS0150001
18,5	3364 e	REINVLS0185001
22,0	3890 €	REINVLS0220001



230V / Three-phase

Power (kW)	Price	Code
0,8	1260 €	REINVLS0075003
1,5	1372 €	REINVLS0015003
2,2	1415 €	REINVLS0022003
4,0	1532 €	REINVLS0040003
5,5	1575 €	REINVLS0055003
7,5	1705 €	REINVLS0750003
11,0	2362 €	REINVLS0110003
15,0	2630 €	REINVLS0150003

230V / Mono-phase

Power (kW)	Price	Code
0,8	1372 €	REINVLS0075002
1,5	1415 €	REINVLS0015002
2,2	1532 €	REINVLS0022002
4,0	1575 €	REINVLS0040002
5,5	1605 €	REINVLS0055002
7,5	2362 €	REINVLS0750002
11,0	2630 €	REINVLS0110002

Control Units

Inverters for Asynchronous motors fans / VS

02.

On-board inverter

400V / Three-phase

Power (kW)	Price	Code
0,75	749 €	REMOTNOR075001
1,1	788 €	REMOTNOR011001
2,2	887 €	REMOTNOR022001

230V / Three-phase

Power (kW)	Price	Code
0,75	819 €	REMOTNOR075003
1,1	857 €	REMOTNOR011003
2,2	1474 €	REMOTNOR022003

230V / Mono-phase

Power (kW)	Price	Code
0,75	920 €	REMOTNOR075002
1,1	920 €	REMOTNOR011002



Bracket kits 03.

Wall bracket

Max. width 150mm

Suitable when the ceiling or the hanging surface allows to directly anchor vertically or horizontally.

Price Code

Tubular

305 €

STKITDESEMP3M0

[150x50mm version - Usable for Ø 5m/ 6m/ 7m]

Tubular

245 €

STKITDESEMP3M2

[50x50mm version - Usable for Ø 0.8m/ 1m/ 1.3m/ 1.6m/ 2.5m/ 3m/ 4m with tubular length included or less than 3m]

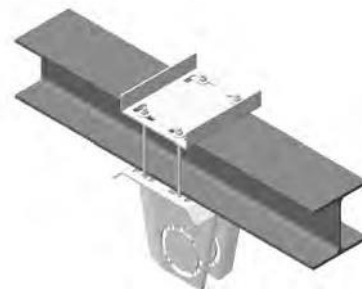
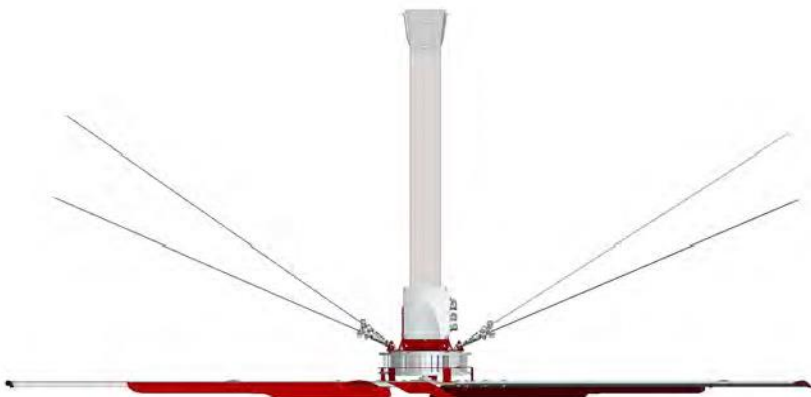

Included kit items

Tubular bracket

58 €

1xkit

STPEZDEUNIVSTA



Counterplate

17 €

1xkit

STPEZDEUNIVPIA



Kit

57 €

1xkit

STKITDETECA000



Tubular 150x50mm

174 €

1xkit

STPEZDETUB13M0



Tubular 150x50mm

348 €

STPEZDETUB16M0



Tubular 50x50mm 4F

101 €

1xkit

STPEZDETUB33M0



Bracket kits

03.

Tubular bracket

Suitable when there are no fixing points and it is necessary to fix the fan between walls or pillars, thus an anchor beam is set up.

Tubular

[150x50mm version - Usable for Ø 5m/ 6m/ 7m]

Price

Code

565 €

STKITDETUB03M0

Tubular

[50x50mm version - Usable for Ø 0.8m/ 1m/ 1.3m/ 1.6m/ 2.5m/ 3m/ 4m with tubular length included or less than 3m]

482 €

STKITDETUB03M2

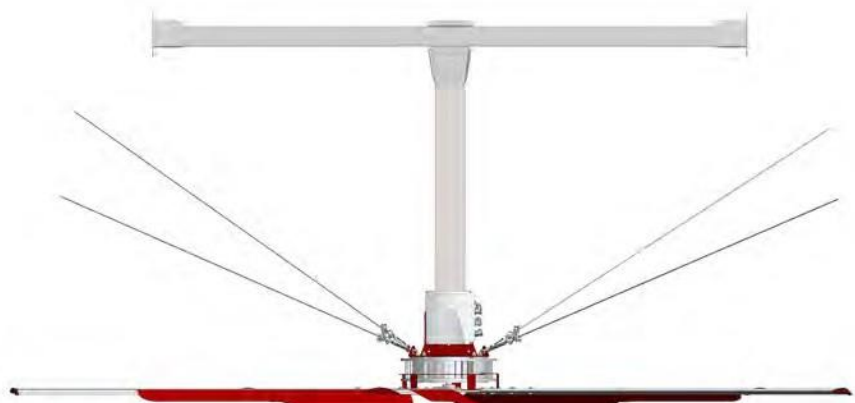

Included kit items

Tubular bracket

58 €

1xkit

STPEZDEUNIVSTA



Counterplate

17 €

1xkit

STPEZDEUNIVPIA



Tubular bracket

45 €

2xkit

STPEZDETUB2STA



Kit

57 €

1xkit

STKITDETECA000



Tubular 150x50mm

174 €

1xkit

STPEZDETUB13M0



3 m

Tubular 150x50mm

348 €

STPEZDETUB16M0



6 m

Tubular

195 €

1xkit

STPEZDETUB26M0



6 m

Tubular 50x50mm 4F

101 €

1xkit

STPEZDETUB33M0



3 m

Bracket kits

03.

Metal strip

Employed when the fixture requires further anchoring points or when the points are far from the vertical positioning of the fan.

	Price	Code
Tubular [150x50mm version - Usable for Ø 5m/ 6m/ 7m]	500 €	STKITDEBANC3M0
Tubular [50x50mm version - Usable for Ø 0.8m/ 1m/ 1.3m/ 1.6m/ 2.5m/ 3m/ 4m with tubular length included or less than 3m]	420 €	STKITDEBANC3M2

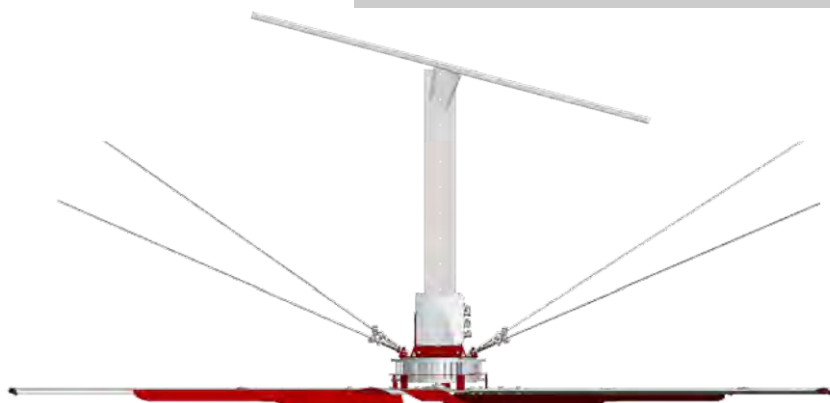

Included kit items

Bracket for metal strip

35 €

1xkit

STPEZDEBANDSTA



Metal strip

208 €

1xkit

STPEZDEBAND000



Kit

57 €

1xkit

STKITDETECA000



Metal strip support "L" shape

17.3 €

2xkit

STPEZDEBANDANG



Tubular 150x50mm

174 €

1xkit

STPEZDETUB13M0

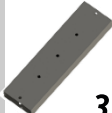

3
m

Tubular 150x50mm

348 €

STPEZDETUB16M0



6
m

Tubular 50x50mm 4F

101 €

1xkit

STPEZDETUB33M0



3
m

Bracket kits

03.

Big bracket

Max. width 180mm

Suitable when the ceiling or the fixing surface allows to directly anchor vertically or horizontally with iron beams with maximum width 180mm.

Price

Code

337 €

STKITDEGRAN3M0

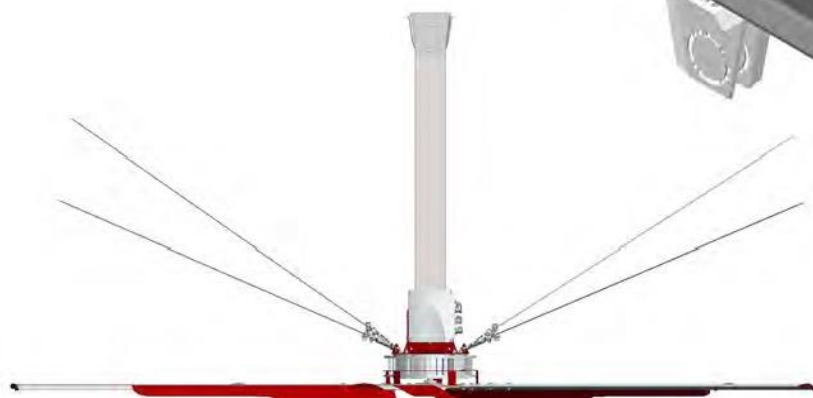
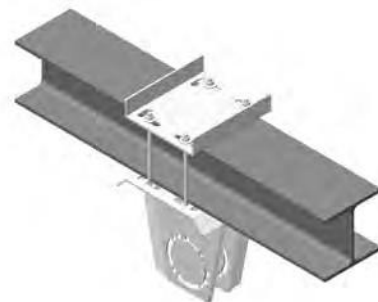

Included kit items

Big bracket

85 €

1xkit

STPEZDEBANDSTA



Counterplate

22 €

1xkit

STPEZDEUNIVPIA



Tubular 150x50mm

174 €

1xkit

STPEZDETUB13M0



3
m

Tubular 150x50mm

348 €

STPEZDETUB16M0

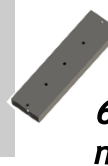

6
m

Kit

57 €

1xkit

STKITDETECA000



Kit accessories

Metal strip support "Z" shape

26 €

STPEZDEPANDZET



Tubular extension

41 €

STPEZDEPROL000



Tubular connection

62 €

STPEZDEATTAGIU



Photoperiod and red light

Photoperiod is a sequence of daylight alternating with hours of darkness which, properly balanced, increases milk production and cow comfort. Over its lifespan, the animal is exposed to well defined cycles of light and darkness. Since cows need 8 hours of darkness to rest optimally, it's difficult to work in the shed at night. However, cows are not able to perceive low intensity red light, which is why the CMP lighting fixtures are equipped with this type of lights.

Dimmable system

Photoperiod works thanks to a continuous calculation of the intensity of natural light: the control unit obtains an average value and, according to it, automatically varies the luminous intensity of the installed lighting fixtures. The floor measurement must return a brightness of **150-200 LUX**.



Light sensor



Control unit

Custom design

CMP offers a preliminary inspection during which all the necessary data are collected. Based on these, our technical department designs a system customized to the needs of the individual customer.

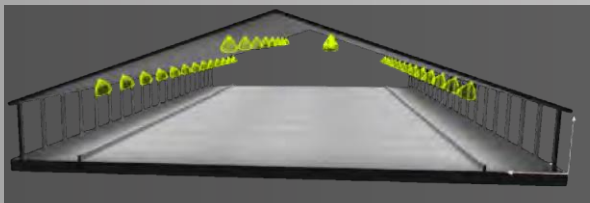

The calculated measurements only involve the width and depth of the barn.

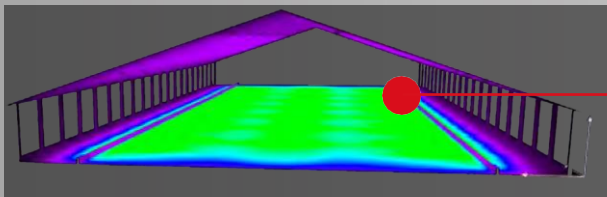

Cluster

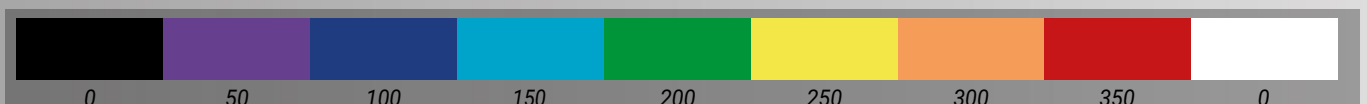

Cluster	Red light solution	White light solution
0/2000 m ²	13,75 €/m ²	11 €/m ²
2000/3000 m ²	12 €/m ²	9,50 €/m ²
> 3000 m ²	11 €/m ²	8,50 €/m ²

Target:
150 - 200 LUX

Lighting

Photoperiod

04.

Red/white light

Dimmable lighting

IP66

IP66 protection



Plug&Play

Power

Price

Code

100W

855 €

ILCOILDIM100LR

150W

915 €

ILCOILDIM150LR

Bracket's price included

Modbus communication

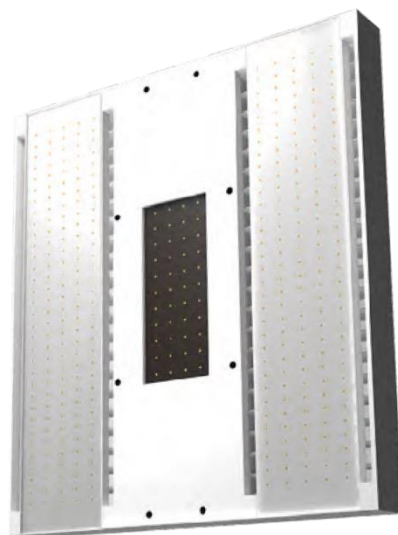

White light

Dimmable lighting

IP66

IP66 protection



Plug&Play

Power

Price

Code

100W

640 €

ILCOILDIM100LW

150W

695 €

ILCOILDIM150LW

Bracket's price included



Smart Total Control 10''

	Price	Code
Display touch 10''	3048 €	CETOUC10000ZS2
Red PLC	3342 €	ILPLC0MOD00000
Light probe (each)	387 €	RRCE0000000064
Modbus redirector	536 €	ACCECASVENT001



Smart Total Control 10''

	Price	Code
Display touch 10''	3048 €	CETOUC10000ZS2
White PLC	3141 €	ILPLC0ANA00000
Light probe (x2)	387 € (x2)	RRCE0000000064



Contacts

Contacts

Email: info@cmp-impianti.com

Phone: +39 030 9686428

Address

Via Amerigo Vespucci, 22

Calvisano (Brescia), IT

Socials



@CMPanimalwelfare



@cmp_animalwelfare



@cmp-animal-welfare



CMP

ANIMAL WELFARE

Via A. Vespucci, 22
25012 Calvisano (BS)
+ 39 030 968 6428
info@cmp-impianti.com

Follow us on:

